

Bplus Technology Co., Ltd. 致宇科技股份有限公司

台北市 114 內湖區洲子街 88 號 9 樓

電話 +886-2-7736-0128

傳真 +886-2-7736-0126

www.bplus.com.tw

sales@bplus.com.tw



PCIe FFC Flexible Adapter

Selection Guide

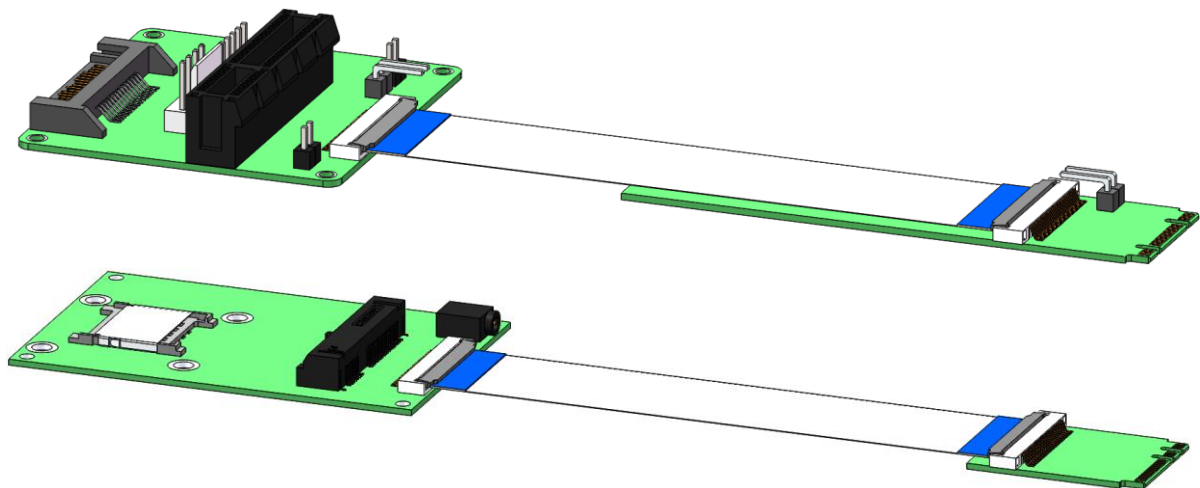

FY 2015

PCI-E Riser extension For PC and Embedded system

CONTENTS

Contents

Part-Number Description _____	1
M.2 (NGFF) Adapter Products List _____	3
PCIe Adapter Products List _____	4
mPCIe Adapter Products List _____	6
Product List _____	8
Contact info _____	9
Company info _____	9

PART-NUMBER DESCRIPTION

Part-Number Description

For example:

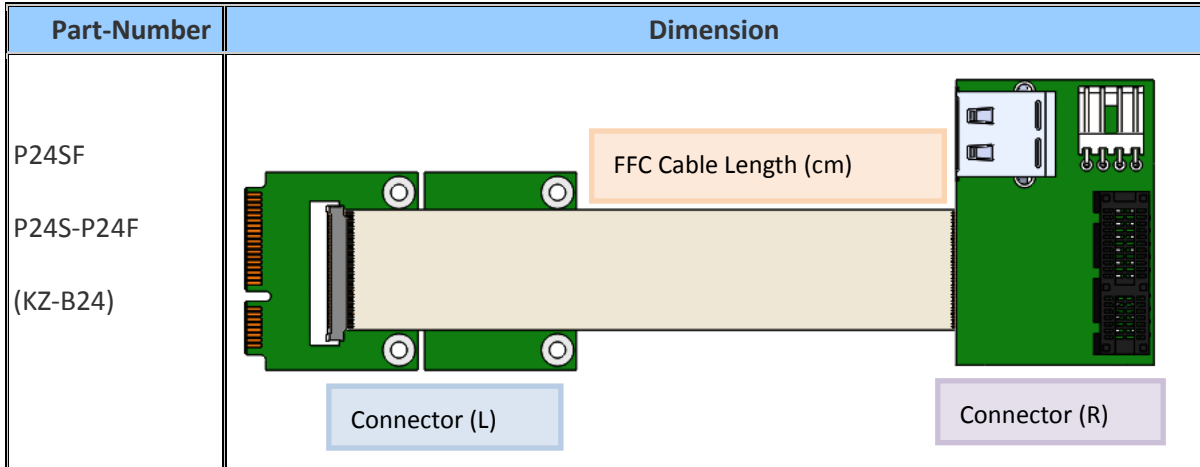

Part Number	P24S-P24F-030B
FFC projects	P (With FPC Cable)
Connector (L)	24 (Serial number)
Connector (R)	
Board	S (System), F (Function)
Length	030A (FFC 30CM Positive)

More PCIe extension cable example:

P24SF
 P24S-P24F-030B
 PCIe to mPCIe FFC 30CM flexible adapter

OEM info

[OEM info] PCIE, USB extension projects components design info					
Plug form(L) Plug	Connector(R) Conn	PCB Board	FFC Length	Finger pin	OEM Code
PCIe gold	PCIe Edge	S (System)	010 (10CM)	A (Positive)	-XX (Code)
ExpressCard	ExpressCard conn	F (Function)	020 (20CM)	B (Reverse)	
mPCIe gold	mPCIe connector		030 (30CM)		
M.2 gold	M.2 connector		060 (60CM)		
USB male	USB female		Other		
(Other)	(Other)				

PART-NUMBER DESCRIPTION

FPC/FFC Material Spec

FFC Part Description

example: **FFC0536P-030B** (FFC-0.5mm-36Pin-30CM-Reverse)

Vendor	Material	Pitch	Total Pin	Length	Pin Location	Material spec	RoHS
BPLUS	FFC	0.5mm	6P	10CM	A. Positive	AWM 20624 80°C VW-1	Compatible
		1.0mm	10P	20CM	B. Reverse		
		other	36P	30CM			
			50P	60CM			
			other	other			

Manufactory info

PCI Express Cable extension, flexible connector push-push slot, riser, extender converter adapter 0.1mm thickness, jumper mini PCI-E, ExpressCard M.2 NGFF key A, B, E, M type test tool full half size 0.5 , 1.0 pitch FFC FPC FR4 PAD OEM EE 3D model PCIE card design

Any kinds of cable you want to OEM, please [contact us](#) anytime.

Custom Samples: Quantities up to 50PCS, lead time: 2~3 weeks.

Custom PCBA design: Charge NRE for US\$300.

Custom product ordered are non-refundable.

Urgently order production Capability 20K/PCS Monthly.

M.2 (NGFF) ADAPTER PRODUCTS LIST

M.2 (NGFF) Adapter Products List

PCIe edge to M.2 adapter,

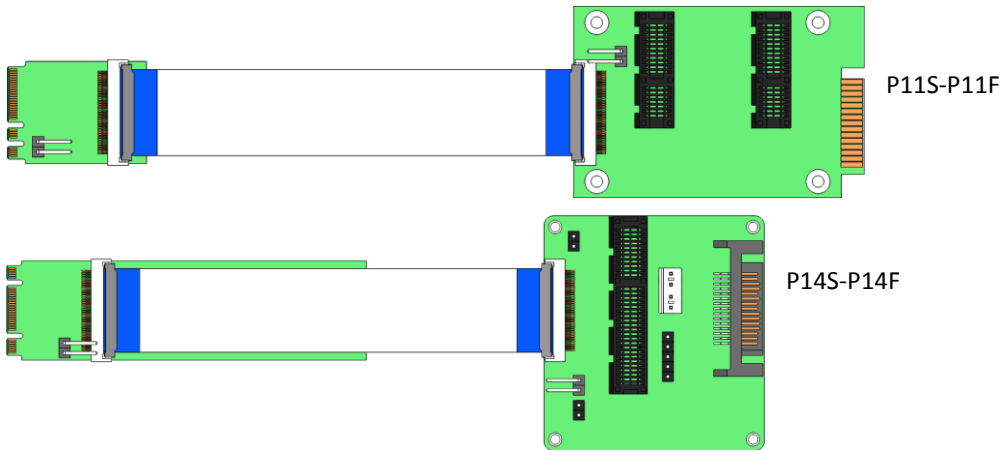

M.2 to M.2 adapter,

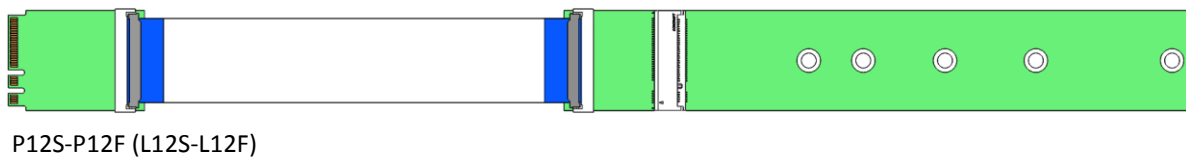

mPCIe to M.2 adapter,

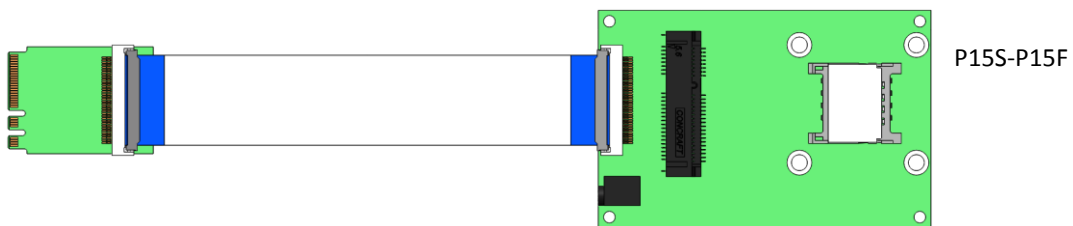

USB to M.2 adapter,



/PCIE ADAPTER PRODUCTS LIST

PCIe Adapter Products List

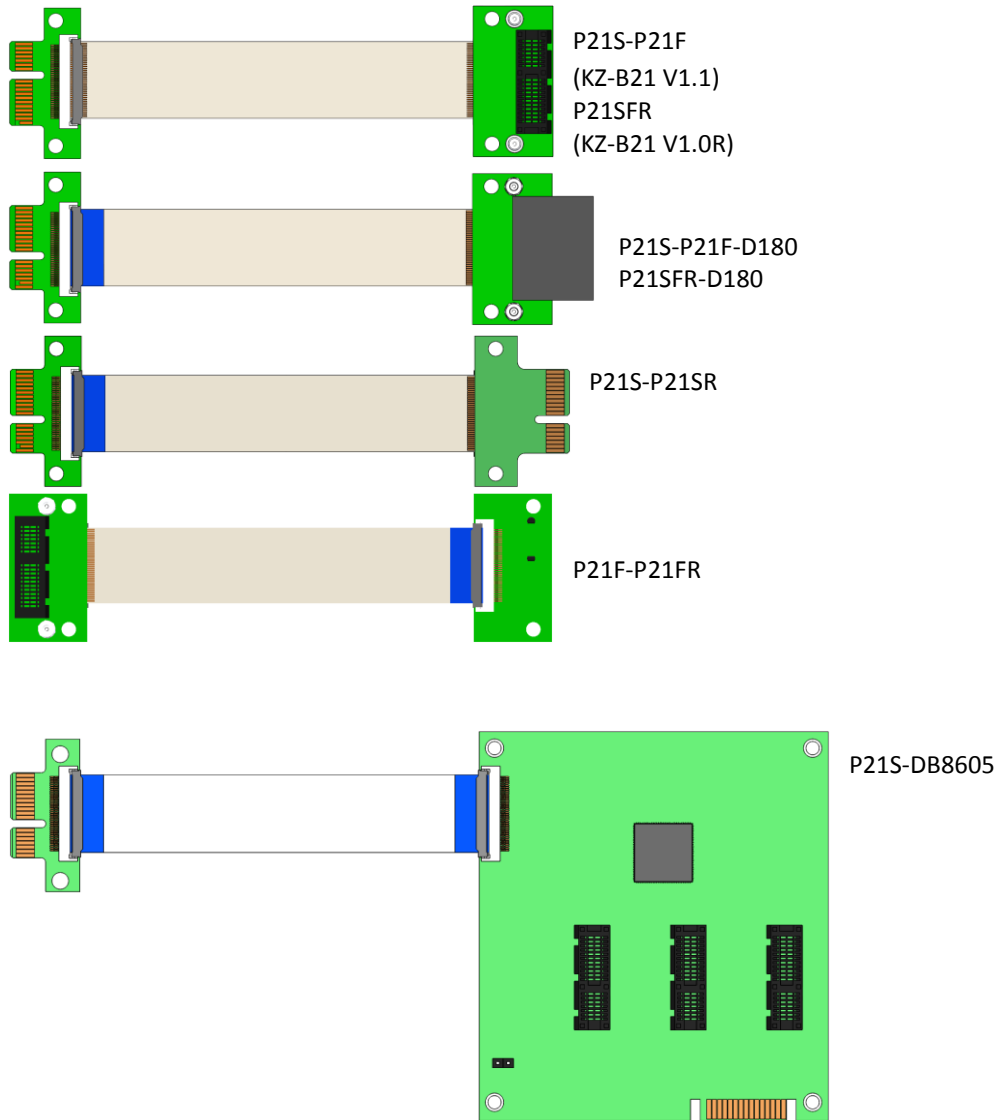

/PCIE ADAPTER PRODUCTS LIST

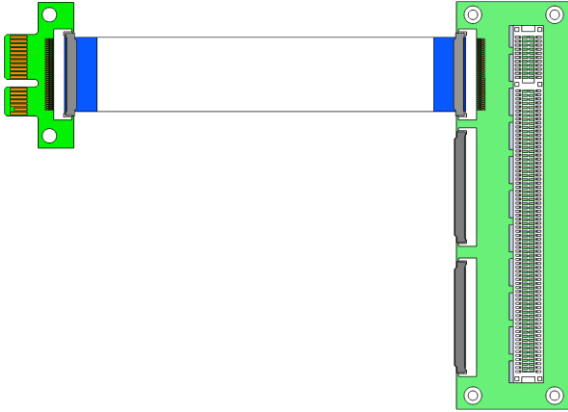

P21S-P27F (KZ-B23x1-DB23)

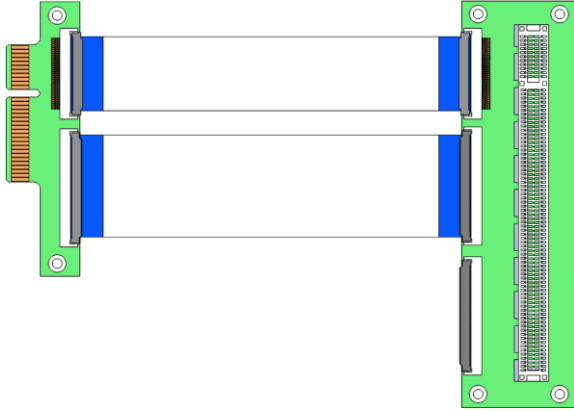

P23S-P27F (KZ-B23x4-DB23)

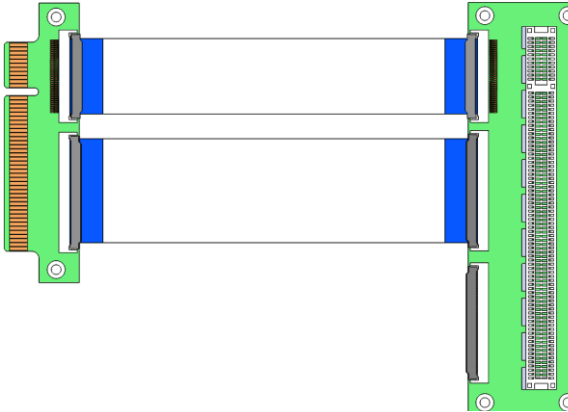

P25S-P27F (KZ-B23x8-DB23)

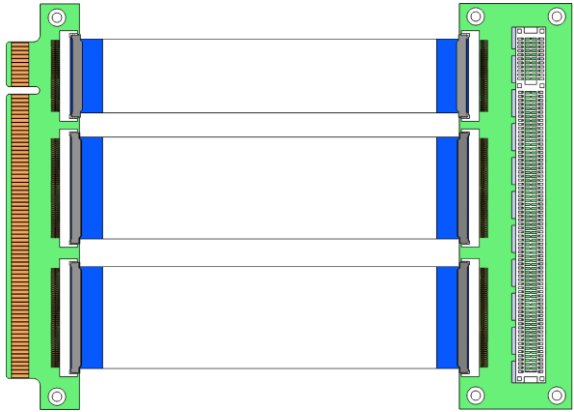

P27S-P27F (KZ-B23x16-DB23)

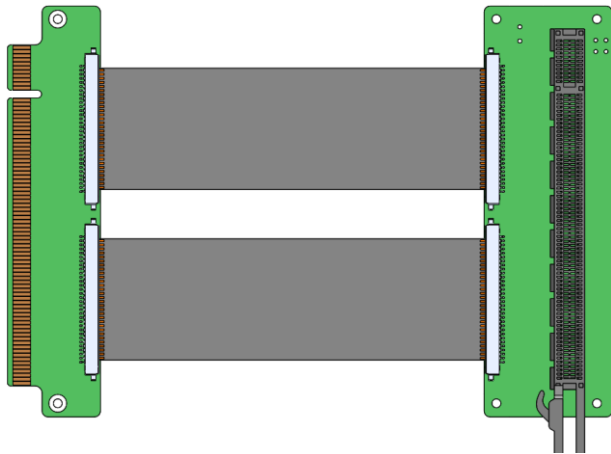

P30S-P30F

MPCIe ADAPTER PRODUCTS LIST

mPCIe Adapter Products List

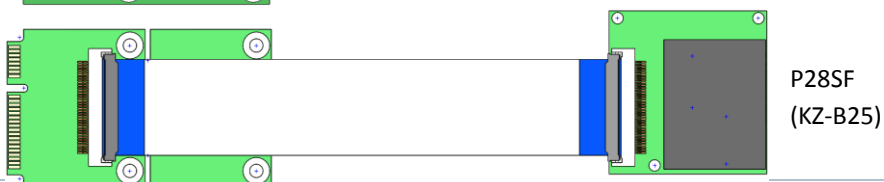
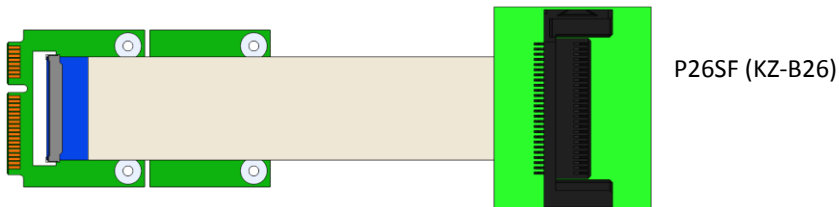
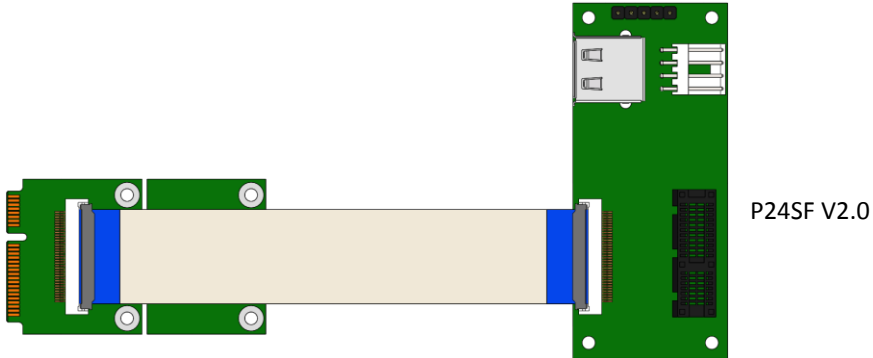
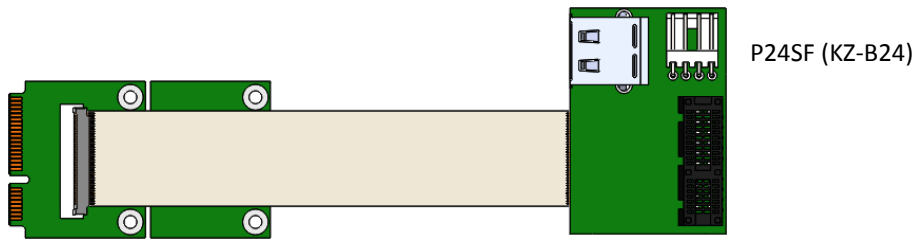
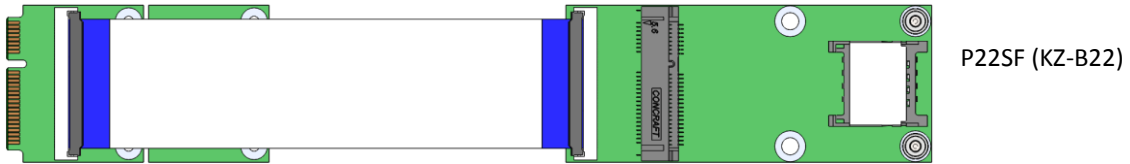

MPCIE ADAPTER PRODUCTS LIST

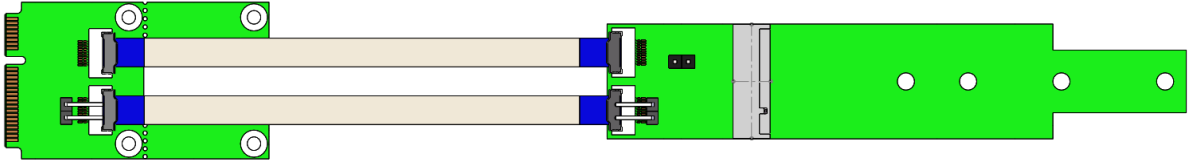

P29SF

PRODUCT LIST/

Product List



Part-Number	Where to buy?	Project Name	Status
P11S-P11F	Web-shop	PCIe 1x edge dual slot to M.2 key A/E adapter	x
P12S-P12F (L12S-L12F)	Web-shop		x
P14S-P14F	Web-shop	PCIe 4x edge to M.2 key B/M adapter	x
P15S-P15F	Web-shop	mPCIe to M.2 key A/E adapter	
P21S-DB8605	Web-shop	PCIe 1x edge x3 slot to PCIe 1x adapter	
P21S-P21F (KZ-B21 V1.1)	Web-shop	PCIe 1x edge to PCIe 1x Extender	Popular
P21S-P21F-D180	Web-shop	PCIe 1x 180° edge to PCIe 1x Extender	
P21S-P27F (KZ-B23x1-DB23)	Web-shop	PCIe 16x edge to PCIe 1x Extender	x
P21SR-P21FR (KZ-B21 V1.0R)	Web-shop	PCIe 1x edge to PCIe 1x reverse Extender	
P22S-P22F (KZ-B22)	Web-shop	mPCIe to mPCIe extender	Popular
P23S-P27F (KZ-B23x4-DB23)	Web-shop	PCIe 16x edge to PCIe 4x Extender	x
P24S-P24F (KZ-B24)	Web-shop	PCIe 1x 90° edge to mPCIe adapter	Popular
P24S-P24F V2.0	Web-shop	PCIe 1x 90° edge to mPCIe adapter	New
P25S-P27F (KZ-B23x8-DB23)	Web-shop	PCIe 16x edge to PCIe 8x Extender	x
P26S-P26F (KZ-B26)	Web-shop	ExpressCard to mPCIe adapter	x
P27S-P27F (KZ-B23x16-DB23)	Web-shop	PCIe 16x edge to PCIe 16x Extender	
P28S-P28F (KZ-B25)	Web-shop	PCIe 1x 180° edge to mPCIe adapter	Popular
P29S-P29F	Web-shop	PCIe to mPCIe adapter	New
P30S-P30F	Web-shop	PCIe 16x edge to PCIe 16x Extender	New
P32S-P32F (U32S-U32F)	Web-shop	USB slot to M.2 key B adapter	x
P34SF-SATA (KZ-B34-SATA)	Web-shop	SATA slot to mPCIe adapter	x
P34SF-USB (KZ-B34-USB)	Web-shop	USB slot to mPCIe adapter	x
PXXXX-OEM	Contact Sales	OEM project	Contact Sales

CONTACT INFO

Contact info

JO YANG
SALES MANAGER



電話 02-77360128 ext. 520
傳真 02-77360126
jo@bplus.com.tw

ROGER TSENG
SUPPORT ENGINEER



電話 02-77360128 ext. 730
傳真 02-77360126
roger@bplus.com.tw

DEREK CHEN
FIELD APPLICATION
ENGINEER



電話 02-77360128 ext. 740
傳真 02-77360126
Derek@bplus.com.tw

Company info

Bplus Technology Co., Ltd. 致宇科技股份有限公司
台北市 114 內湖區洲子街 88 號 9 樓
電話 +886-2-7736-0128
傳真 +886-2-7736-0126
www.bplus.com.tw

